



NATIONAL POWER CORPORATION

SUPPLEMENTAL / BID BULLETIN NO. 1 to the Bid Documents for the:

SUPPLY AND DELIVERY OF CONSOLIDATED MECHANICAL SPARE PARTS FOR CUMMINS DIESEL ENGINE FOR PALAWAN AREA UNDER PR NO. S1-PWN24-002 / PB240213-CM00039

05 FEBRUARY 2024

All prospective bidders and authorized copy holders of the Bid Documents of the above - mentioned project are hereby advised of the change and additional information in the Bid Documents, to wit:

1. DELIVERY PERIOD / CONTRACT DURATION:

FROM	TO
Ninety (90) Calendar Days	<u>ONE HUNDRED TWENTY (120) CALENDAR DAYS</u>

2. REFERENCE PICTURES FOR ITEM NO. 29 (CHARGE AIR COOLER):

"Please see attached Annex A"

3. REFERENCE PICTURES FOR ITEM NO. 122 (RADIATOR 200KW CUMMINS):

"Please see attached Annex B"

4. REFERENCE PICTURES FOR ITEM NO. 123 (RADIATOR 600KW CUMMINS):

"Please see attached Annex C"

5. REFERENCE PICTURES FOR ITEM NO. 124 (RADIATOR 80KW CUMMINS):

"Please see attached Annex D"

6. REFERENCE PICTURES FOR ITEM NO. 125 (RADIATOR 100KW CUMMINS):

"Please see attached Annex E"

7. DESCRIPTION OF ITEM NO. 39:

FROM	TO
ENGINE OVERHAUL KIT 200KW CUMMINS	ENGINE OVERHAUL KIT 200KW CUMMINS Content: (1) O-Ring Seal, 3046201 (1) Breather Mounting Seal, 3073966 (1) O-Ring Seal, 3627695 (2) O-Ring Seals, 3678603 (1) O-Ring Seal, 3682177 (1) Turbocharger Gasket, 3755843 (1) O-Ring Seal, 3883284 (1) Gasket, 3901356



NATIONAL POWER CORPORATION

Gabriel Y. Itchon Building
Senator Miriam P. Defensor-Santiago Avenue (formerly BIR Road)
corner Quezon Avenue, Diliman, Quezon City 1100, Philippines
Tel. Nos. (632) 8921-3541 to 80 • Fax No. (632) 8921-2468
Website: www.napocor.gov.ph



	(1) Copper Gasket, 3920773 (1) Turbo House O-Ring Seal, 3922794 (1) O-Ring Seal, 3931824 (6) Mid-Range XPI Injector Seals, 3937142 (1) Accessory Drive Support Gasket, 3685614 (1) Valve Cover Gasket, 3959798 (2) Sealing Washers, 3963983 (5) Sealing Washers, 3963988 (23) Sealing Washers, 3963990 (1) Connection Gasket, 3967891 (1) O-Ring Seal, 3973512 (3) O-Ring Seals, 4010519 (2) O-Ring Seals, 4010643 (6) O-Ring Seals, 4062328 (6) O-Ring Seals, 4890926 (1) Sealing Washer, 4934280 (6) Exhaust Manifold Gaskets, 5269779 (1) Rocker Lever Housing Gasket, 3966708 (1) Cylinder Head Gasket, 5529515 (1) Oil Drain Gasket, 5264569
--	--

8. DESCRIPTION OF ITEM NO. 40:

FROM	TO
ENGINE OVERHAUL KIT 80KW CUMMINS	ENGINE OVERHAUL KIT 80KW CUMMINS Content: Upper Engine Gasket Set Lower Engine Gasket Set Piston Kits Main Bearings Rod Bearings 1 Set of Overhaul Gasket Kit 6 Cylinder Liners 6 Pistons STD 6 Piston Pins 12 Snap Rings 6 Rod Bushings Set Rings For 6 Pistons STD 1 Set of Main Bearings 1 Set of Rod Bearings 1 Set of Thrust Bearing 6 Intake Valves 6 Exhaust Valves 12 Valve Guides 6 Intake Valves Seats 6 Exhaust Valves Seats

9. DESCRIPTION OF ITEM NO. 41:

FROM	TO
ENGINE OVERHAUL KIT 60KW CUMMINS	ENGINE OVERHAUL KIT 60KW CUMMINS Content: Upper Engine Gasket Set Lower Engine Gasket Set Piston Kits Main Bearings Rod Bearings 1 Set of Overhaul Gasket Kit

	6 Cylinder Liners 6 Pistons STD 6 Piston Pins 12 Snap Rings 6 Rod Bushings Set Rings For 6 Pistons STD 1 Set of Main Bearings 1 Set of Rod Bearings 1 Set of Thrust Bearing 6 Intake Valves 6 Exhaust Valves 12 Valve Guides 6 Intake Valves Seats 6 Exhaust Valves Seats
--	--

All other terms and conditions shall remain the same.

For the information and guidance of all authorized copy holders of the Bid Documents and prospective bidders.

For the Bids and Awards Committee:

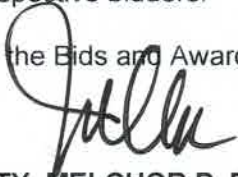

ATTY. MELCHOR P. RIDULME
Vice President, Office of the Legal Counsel and
Chairman, Bids and Awards Committee

ANNEX A:

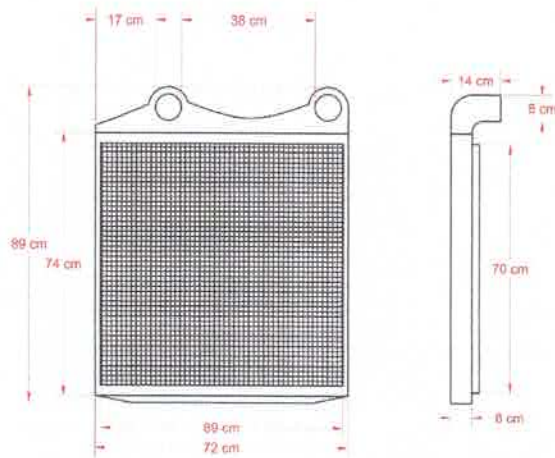
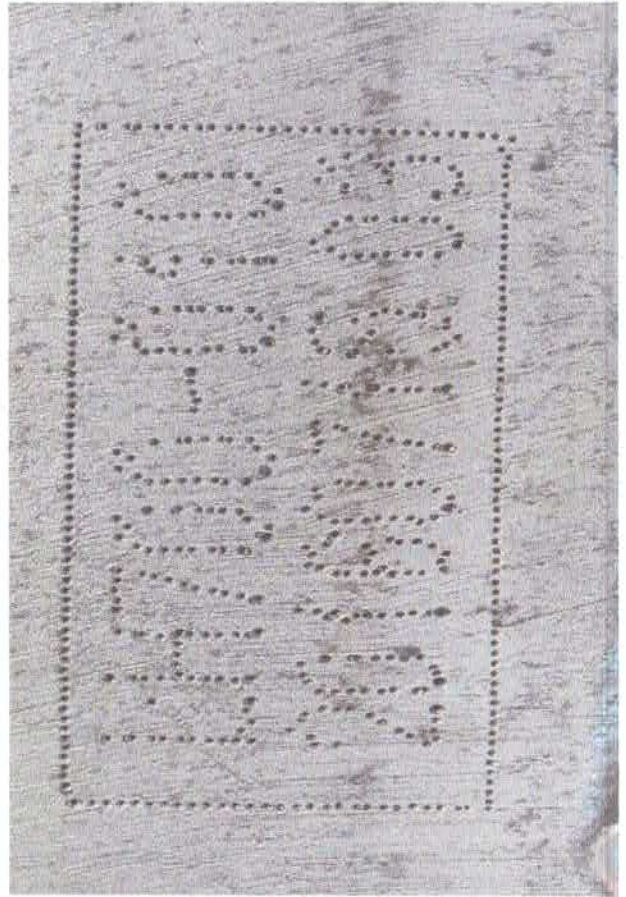
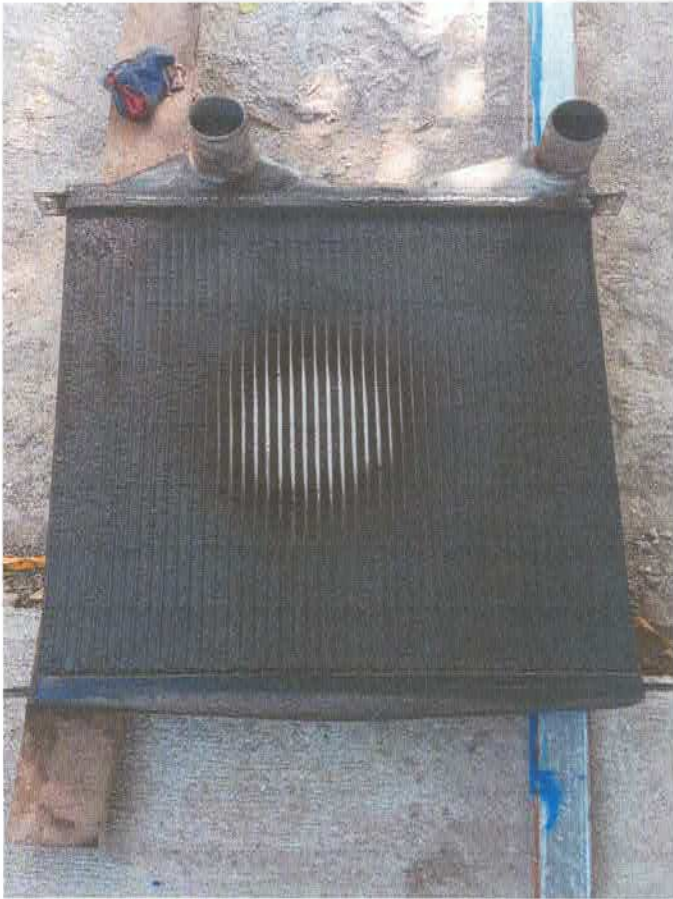

**BITON DPP
CUMMINS CHARGE AIR COOLER**

ANNEX B:

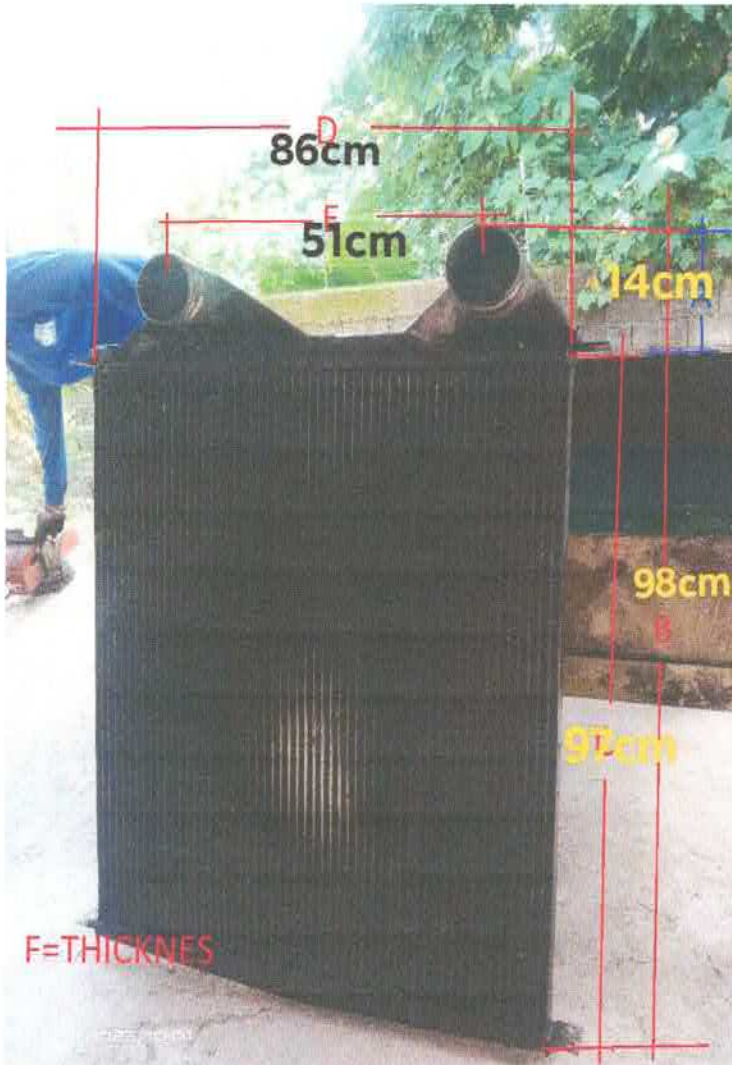

ANNEX C:

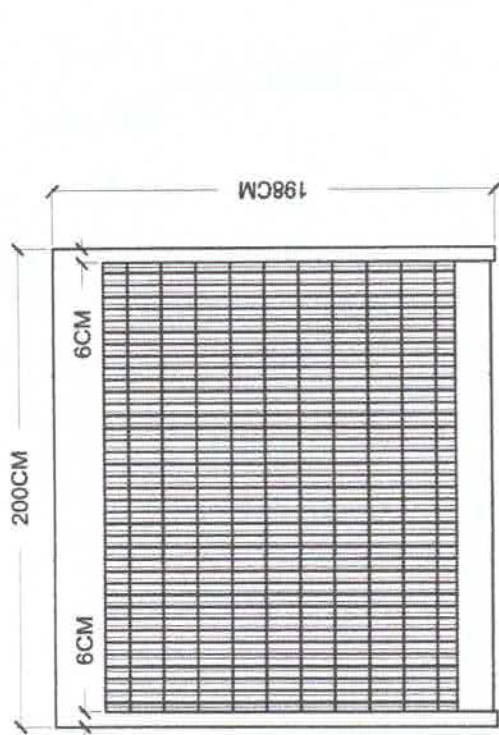

FRONT VIEW

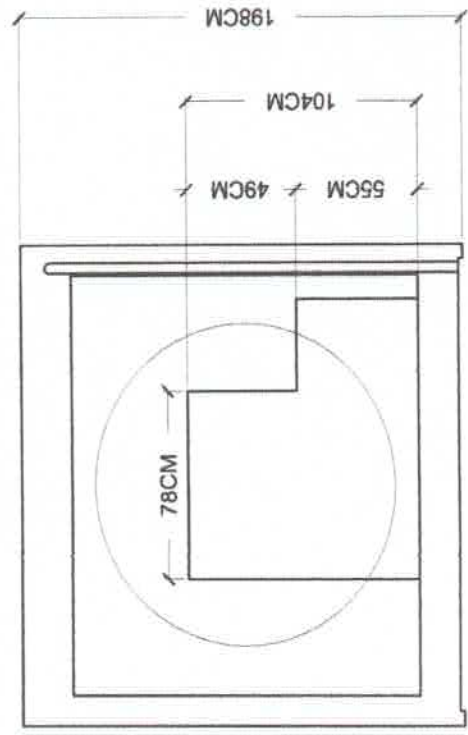

REAR VIEW

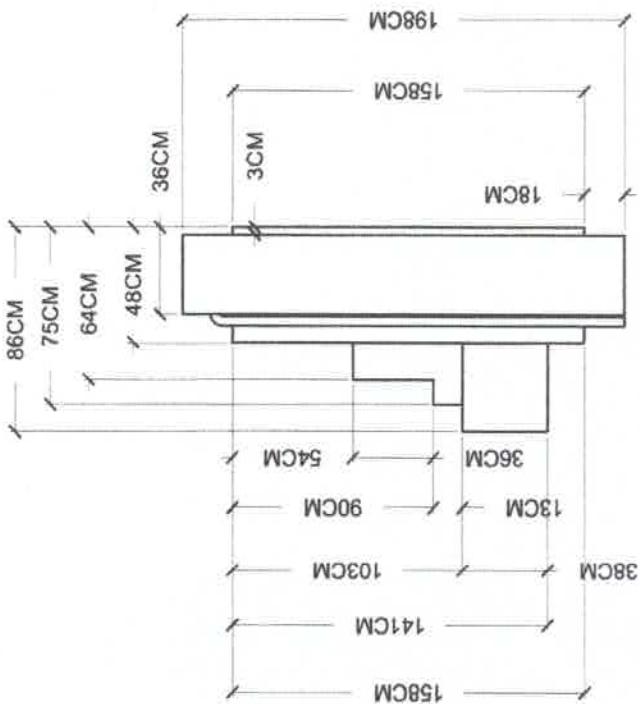

LEFT SIDE VIEW

**RADIATOR OF
 KTA38-G1 CUMMINS**

ANNEX D:

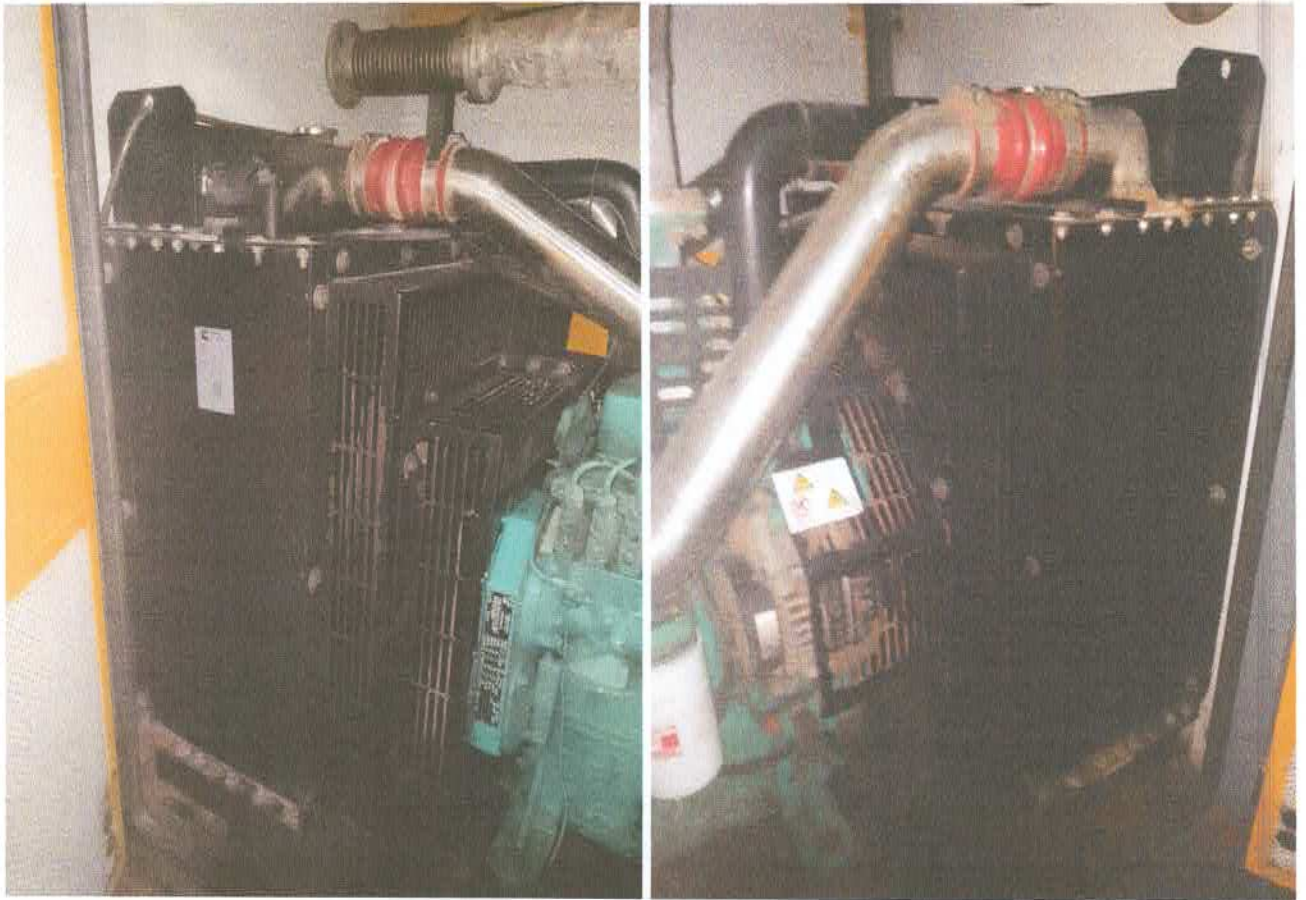

ANNEX E:

